

Fontini

France



Fontini

Société familiale,
fabricants depuis 1950

En 1950, Joan Font González fonde une petite usine de fabrication de matériel électrique dans la région de Barcelone. Aujourd'hui, son ^os vivant au sein de Fontini, la famille Font est encore présente pour faire perdurer son rêve, faire de la marque le leader des appareillages décoratifs dans le monde.

Notre trajectoire nous amène à célébrer le 20^e anniversaire de notre collection la plus iconique et emblématique Garby. 20 ans de traditions et de savoir faire pour fabriquer la collection rétro la plus reconnue dans le monde.

Dans une société de consommation globale où les produits sont fabriqués à la chaîne, nous sommes fidèles à notre esprit en fabricant nos collections de façon manuelle et artisanale pour donner une âme à nos collections. Le résultat est une gamme complète d'excellente qualité au design « vintage » avec toutes les normes et exigences actuelles.

Depuis ses débuts Fontini s'est toujours orienté vers les marchés internationaux et nous sommes, aujourd'hui, présents dans plus de 50 pays avec un grand réseau de distribution qui est pour nous l'extension de la famille.

Une famille formée par des professionnels qui aiment les valeurs du projet et de notre produit.



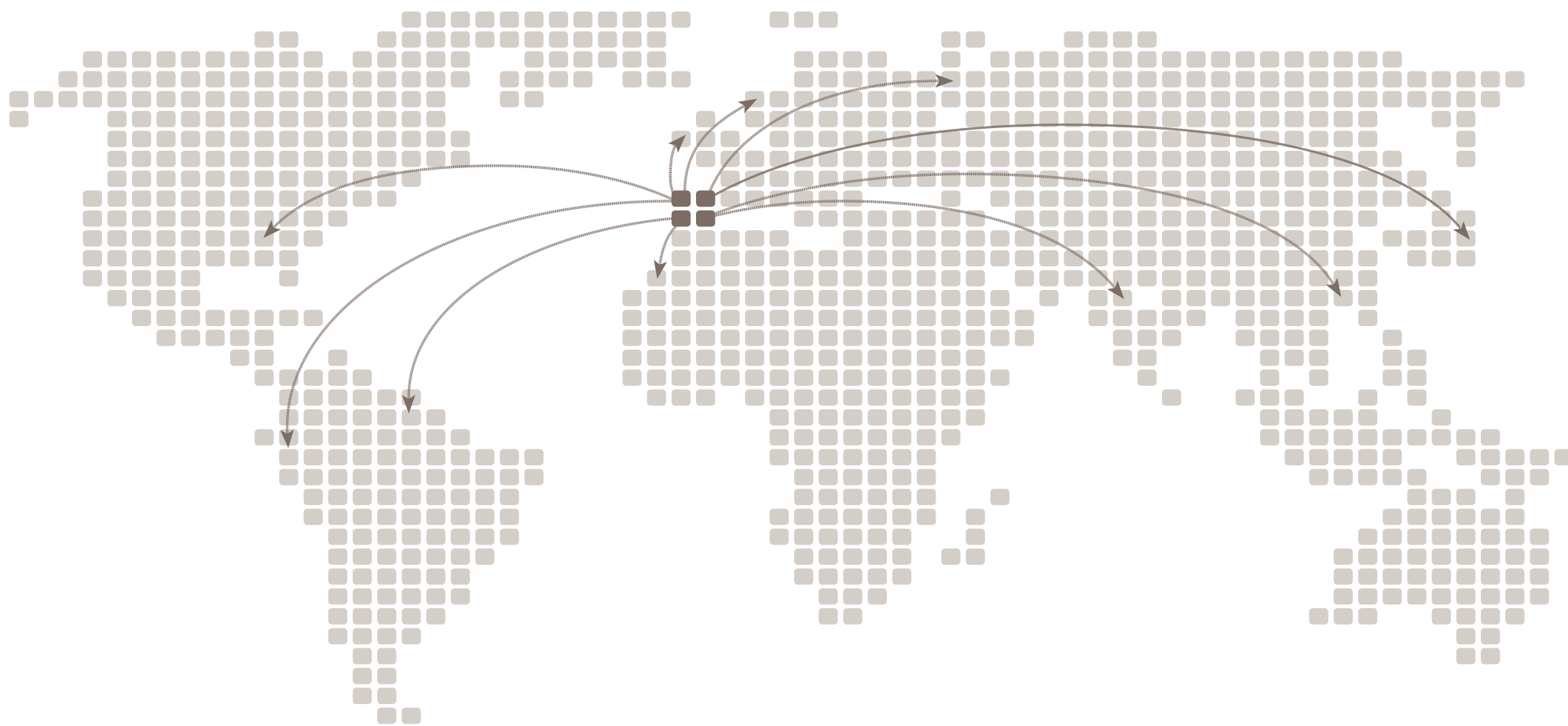

GARBY
Collection

Fontini



GARBY

Collection

Manettes et vis

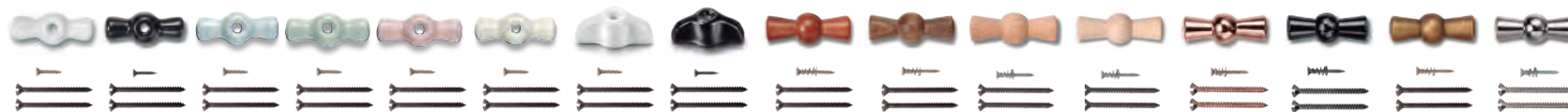
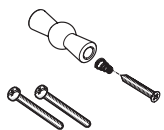

Mécanismes

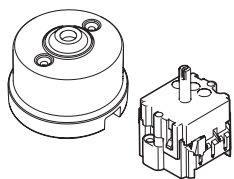

Socles

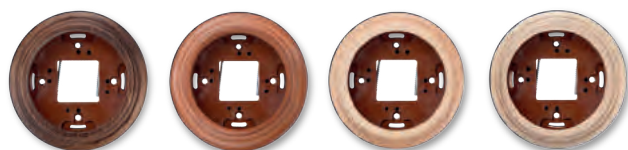
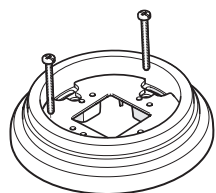

Socles pour tube

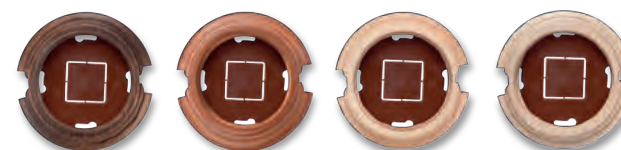

Plaques

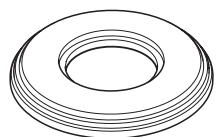

Les plaques requièrent adaptateur pour un montage en saillie



GARBY

Collection



17
Porcelaine Blanche



27
Porcelaine Noire



85
Porcelaine Coton



86
Porcelaine Vert ille



87
Porcelaine Camille











88
Porcelaine Cru

















GARBY

Collection

Manettes. Porcelaine

| | | | | | | |
|---|---|-------------|----|-----|----|---|
|  | Manette rotative porcelaine blanche. Vis patinées | Pack 1 ud. | 30 | 967 | 17 | 1 |
| | | Pack 5 uds. | 30 | 967 | 17 | 7 |
|  | Manette rotative porcelaine noire. Vis noire | Pack 1 ud. | 30 | 967 | 27 | 1 |
| | | Pack 5 uds. | 30 | 967 | 27 | 7 |
|  | Manette rotative porcelaine Coton. Vis patinées | Pack 1 ud. | 30 | 967 | 85 | 1 |
| | | Pack 5 uds. | 30 | 967 | 85 | 7 |
|  | Manette rotative porcelaine Vert ille. Vis patinées | Pack 1 ud. | 30 | 967 | 86 | 1 |
| | | Pack 5 uds. | 30 | 967 | 86 | 7 |
|  | Manette rotative porcelaine Camille. Vis patinées | Pack 1 ud. | 30 | 967 | 87 | 1 |
| | | Pack 5 uds. | 30 | 967 | 87 | 7 |
|  | Manette rotative porcelaine Crue. Vis patinées | Pack 1 ud. | 30 | 967 | 88 | 1 |
| | | Pack 5 uds. | 30 | 967 | 88 | 7 |
|  | Manette rotative porcelaine rétro blanche. Vis patinées | Pack 1 ud. | 30 | 930 | 17 | 1 |
| | | Pack 5 uds. | 30 | 930 | 17 | 7 |
|  | Manette rotative porcelaine rétro noire. Vis noire | Pack 1 ud. | 30 | 930 | 27 | 1 |
| | | Pack 5 uds. | 30 | 930 | 27 | 7 |

Manettes. Bois / Laitón

| | | | | | | | |
|---|---|---|-------------|----|-----|----|---|
|  |  | Manette rotative hêtre couleur miel: Vis patinées | Pack 1 ud. | 30 | 967 | 19 | 1 |
| | | | Pack 5 uds. | 30 | 967 | 19 | 7 |
|  |  | Manette rotative hêtre vieilli . Vis patinées | Pack 1 ud. | 30 | 967 | 21 | 1 |
| | | | Pack 5 uds. | 30 | 967 | 21 | 7 |
|  |  | Manette rotative hêtre naturel. Vis patinées | Pack 1 ud. | 30 | 967 | 81 | 1 |
| | | | Pack 5 uds. | 30 | 967 | 81 | 7 |
|  |  | Manette rotative hêtre sans vernis. Vis patinées | Pack 1 ud. | 30 | 967 | 00 | 1 |
| | | | Pack 5 uds. | 30 | 967 | 00 | 7 |
|  |  | Manette rotative cuivre brillant. Vis cuivre | Pack 1 ud. | 30 | 967 | 31 | 1 |
| | | | Pack 5 uds. | 30 | 967 | 31 | 7 |
|  |  | Manette rotative nickel noir. Vis noire | Pack 1 ud. | 30 | 967 | 30 | 1 |
| | | | Pack 5 uds. | 30 | 967 | 30 | 7 |
|  |  | Manette rotative laiton vieilli. Vis patinées | Pack 1 ud. | 30 | 967 | 83 | 1 |
| | | | Pack 5 uds. | 30 | 967 | 83 | 7 |
|  |  | Manette rotative chrome. Vis chromées | Pack 1 ud. | 30 | 967 | 26 | 1 |
| | | | Pack 5 uds. | 30 | 967 | 26 | 7 |

GARBY

Collection avec passe câble



GARBY

Collection avec passe câble

Mécanismes



Interrupteur unipolaire

10AX - 250V~

30

306

--

1

Va et vient

10AX - 250V~

30

308

--

1

Permutateur

10AX - 250V~

30

304

--

1

Interrupteur bipolaire

10AX - 250V~

30

314

--

1

Mécanisme pour volets roulants
(pour moteurs 1,66A)

10A - 250V~

30

342

--







1

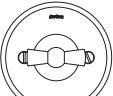
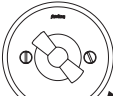
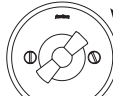

GARBY

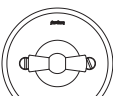
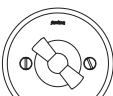
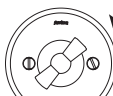
Collection avec passe câble

Mécanismes

| | | | |
|---|---|--|--------------------|
|  | <p>Poussoir rotatif 10AX - 250V~</p> | <p>Position de repos</p> <p>SORTIE</p>  OFF  ON  ON | <p>30 328 -- 1</p> |
|  | <p>Double poussoir rotatif 10AX - 250V~</p> | <p>Position de repos</p> <p>SORTIE</p>  OFF  ON 1  ON 2 | <p>30 344 -- 1</p> |
|  | <p>Bouton poussoir</p> | <p>10AX - 250V~ 24V DC</p> | <p>30 310 -- 2</p> |
| <p>Finitions non disponibles: 85 - 86 - 87 - 88</p> | | | |
|  | <p>Bouton poussoir</p> | <p>10AX - 250V~ 24V DC</p> | <p>30 312 -- 2</p> |
|  | <p>Double bouton poussoir</p> | <p>10AX - 250V~ 24V DC</p> | <p>30 343 -- 2</p> |
| <p>Finitions non disponibles: 85 - 86 - 87 - 88</p> | | | |



GARBY

Collection avec passe câble

Prises de courant



Prise de courant sans terre
Carcasse en porcelaine

16A - 250V~

30

205

--

2

Finitions non disponibles: 85 - 86 - 87 - 88



Prise de courant avec terre
Carcasse en porcelaine

16A - 250V~

30

211

--

2

Chargeur USB double



Chargeur USB double

Il permet le chargement d'appareils tels que les smartphones et les tablettes.

Charge rapide avec un seul appareil connecté et charge lente avec deux appareils connectés :

- 1 x 2,6 A (1 sortie connectée)
- 2 x 1,3 A (2 sorties connectées)

30

765

--

2



GARBY

Collection avec passe câble

Prises VDI simples



RJ12

30

701

--

1

RJ45 CAT 6

30

702

--

1

RJ45 CAT 6A

30

760

--

1



GARBY

Collection avec passe câble

Prises VDI doubles



RJ12 double

30

706

--

2

RJ45 CAT 6 double

30

707

--

2

RJ12 + RJ45 CAT 6 double

30

708

--

2



RJ45 CAT 6A double

30

761

--

2



GARBY

Collection avec passe câble

Prises TV



Prise signal RTV-SAT égalisée

Prise unique

30

712

--

2

Prise intermédiaire A

30

713

--

2

Prise intermédiaire B

30

714

--

2

Prise finale

30

709

--

2



GARBY

Collection avec passe câble



Couvercle aveugle

30

656

--

2



Sortie de câbles

Ø 8,5mm

30

927

--

2



GARBY

Collection sans passe câble



GARBY

Collection sans passe câble

Bête d'encastrement



Boîte d'encastrement pour Garby et Dimbler. Avec entretoise

30 993 02 0

Système de rétention de boîtes pour panneau de placoplâtre

30 995 00 0

Boîte d'encastrement spéciale

Parfois, des produits apparaissent et parviennent à dépasser les limites de leur conception, de leurs applications, de leur utilisation et finissent par devenir des icônes. C'est le cas, par exemple, de la Collection Garby. Un produit développé pour une installation en saillie mais produisant un pouvoir d'attraction chez de nombreux clients qui les amène à vouloir l'utiliser dans une installation encastrée.

Une alternative pour cette application, c'est d'utiliser « l'adaptateur pour des plaques en saillie avec support » combiné avec les plaques de Garby Colonial, mais cette alternative ne satisfait pas toujours les amateurs de Garby.

C'est pourquoi nous vous présentons maintenant le nouveau boîtier à encastrer spécial pour Garby.

Un produit conçu pour pouvoir adapter la Collection Garby à une installation encastrée sans ajout d'éléments supplémentaires.

Il est conçu pour permettre de relier plusieurs éléments et créer ainsi des groupes multiples de mécanismes séparés entre eux de 2 cm grâce au séparateur fourni dans la même boîte. Il est adapté pour être installé sur des murs en briques ou en placo en utilisant des accessoires tels que des vis de retenue ; un trou de 51 mm étant nécessaire dans ce cas-là.

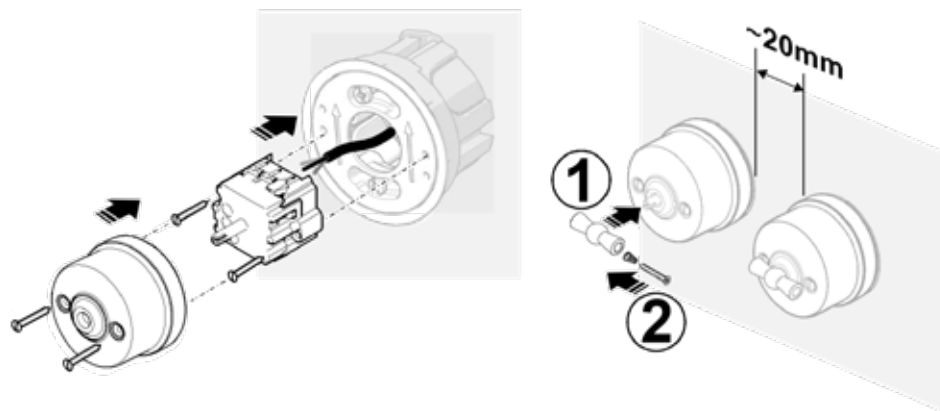

Mécanismes sans passe câbles

Conçu pour soigner l'esthétique de l'ensemble des installations encastrées où une entrée de câble en saillie n'est plus nécessaire.

Toutes les références de Garby peuvent être fournies dans un format « sans passage de câbles ».

Toutes les références Garby avec passe câble ont un équivalent sans passe câble. Si la référence avec passe câble se termine par 2, la référence sans passe câbles se termine par 5, et celles terminant par 1 sont changées en 6.

GARBY

Collection sans passe câble

Mécanismes



Interrupteur unipolaire

10AX - 250V~

30

306

--

6

Va et vient

10AX - 250V~

30

308

--

6

Permutateur

10AX - 250V~

30

304

--

6

Interrupteur bipolaire

10AX - 250V~

30

314

--

6

Mécanisme pour volets roulants
(pour moteurs 1,66A)

10A - 250V~

30

342

--

6



GARBY

Collection sans passe câble

Mécanismes



Poussoir rotatif
10AX - 250V~

SORTIE

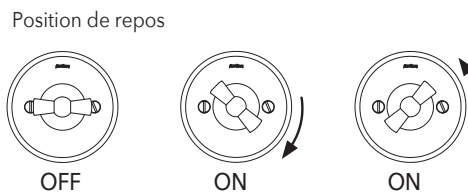

30 328 -- 6

Double poussoir rotatif
10AX - 250V~

SORTIE

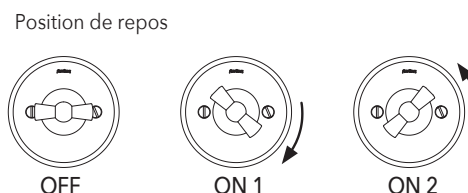

30 344 -- 6



Bouton poussoir

10AX - 250V~
24V DC

30 310 -- 5

Finitions non disponibles: 85 - 86 - 87 - 88



Bouton poussoir

10AX - 250V~
24V DC

30 312 -- 5



Double bouton poussoir

10AX - 250V~
24V DC

30 343 -- 5

Finitions non disponibles: 85 - 86 - 87 - 88



GARBY

Collection sans passe câble

Prises de courant



Prise de courant sans terre

16A - 250V~

Carcasse en porcelaine

30

205

--

5



Prise de courant avec terre

16A - 250V~

Carcasse en porcelaine

30

211

--

5

Chargeur USB double



Chargeur USB double

Il permet le chargement d'appareils tels que les smartphones et les tablettes.

Charge rapide avec un seul appareil connecté et charge lente avec deux appareils connectés :

- 1 x 2,6 A (1 sortie connectée)
- 2 x 1,3 A (2 sorties connectées)

30

765

--

5

17



27



GARBY

Collection sans passe câble

Prises VDI simples



RJ12

30

701

--

5

RJ45 CAT 6

30

702

--

5

RJ45 CAT 6A

30

760

--

5

17



27



GARBY

Collection sans passe câble

Prises informatiques sans passe câble



Double prise

RJ12

30

706

--

5

RJ45 CAT6

30

707

--

5

RJ12 + RJ45 CAT6

30

708

--

5



Double prise

RJ45 CAT6A
blindé

30

761

--

5



GARBY

Collection sans passe câble

Prises de TV



Prise signal RTV-SAT égalisée

Prise unique

30

712

--

5

Prise intermédiaire
A

30

713

--

5

Prise intermédiaire
B

30

714

--

5

Prise finale

30

709

--

5

17



27



GARBY

Collection sans passe câble

Autres fonctions sans passe câble



Couvercle aveugle

30

656

--

5



Sortie de câbles

Ø 8,5mm

30

927

--

5



GARBY
Collection



GARBY

Collection

Bois



Hêtre vieilli



Hêtre couleur miel

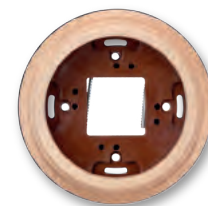

Hêtre naturel

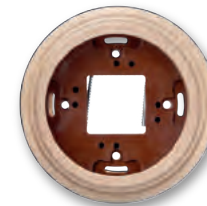

Hêtre sans vernis

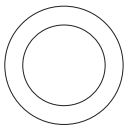
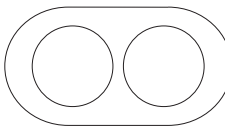
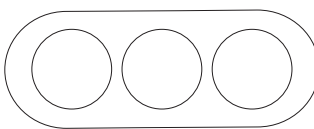
| | | | | | | |
|--|------------|-------------|-------------|-------------|-------------|-------------|
|  | 1 élément | Ø 95x22mm | 30 801 21 2 | 30 801 19 2 | 30 801 81 2 | 30 801 00 2 |
|  | 2 éléments | 181x95x22mm | 30 802 21 2 | 30 802 19 2 | 30 802 81 2 | 30 802 00 2 |
|  | 3 éléments | 252x95x22mm | 30 803 21 2 | 30 803 19 2 | 30 803 81 2 | 30 803 00 2 |



Support à griffes pour boîtier universel sans vis.

Uniquement pour socle: **3080X...**

20 901 97 2

Tous les socles sont vendus avec adaptateur inclus pour une installation en surface ou boîtier encastré.

GARBY

Collection

Bois pour tube



Hêtre vieilli





Hêtre couleur miel



Hêtre naturel

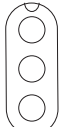
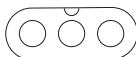

Hêtre sans vernis

| | | | | | | |
|------------|---|---|-------------|-------------|-------------|-------------|
| 1 élément |  | 1 trou Ø 95x22mm | 30 821 21 2 | 30 821 19 2 | 30 821 81 2 | 30 821 00 2 |
| 2 éléments |  | 1 trou installation verticale 181x95x22mm | 30 822 21 2 | 30 822 19 2 | 30 822 81 2 | 30 822 00 2 |
| |  | 1 trou installation horizontale 181x95x22mm | 30 832 21 2 | 30 832 19 2 | 30 832 81 2 | 30 832 00 2 |
| 3 éléments |  | 1 trou installation verticale 252x95x22mm | 30 823 21 2 | 30 823 19 2 | 30 823 81 2 | 30 823 00 2 |
| |  | 1 trou installation horizontale 252x95x22mm | 30 833 21 2 | 30 833 19 2 | 30 833 81 2 | 30 833 00 2 |

GARBY

Collection

Bois



Hêtre vieilli





Hêtre couleur miel



Hêtre naturel

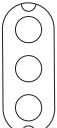
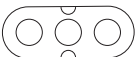

Hêtre sans vernis

| | | | | | | |
|------------|---|--|-------------|-------------|-------------|-------------|
| 1 élément |  | 2 trous Ø 95x22mm | 30 841 21 2 | 30 841 19 2 | 30 841 81 2 | 30 841 00 2 |
| 2 éléments |  | 2 trous installation verticale 181x95x22mm | 30 842 21 2 | 30 842 19 2 | 30 842 81 2 | 30 842 00 2 |
| |  | 2 trous installation horizontale 181x95x22mm | 30 852 21 2 | 30 852 19 2 | 30 852 81 2 | 30 852 00 2 |
| 3 éléments |  | 2 trous installation verticale 252x95x22mm | 30 843 21 2 | 30 843 19 2 | 30 843 81 2 | 30 843 00 2 |
| |  | 2 trous installation horizontale 252x95x22mm | 30 853 21 2 | 30 853 19 2 | 30 853 81 2 | 30 853 00 2 |

GARBY

Collection



GARBY

Collection

Porcelaine

Les plaques requièrent un adaptateur pour un montage en saillie



Blanche



Noire



Décor



Craquelé

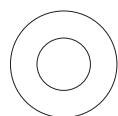

1 élément Ø 100x12mm

31 801 17 2

31 801 27 2

31 801 61 2

31 801 09 2



2 éléments 175x100x12mm

31 802 17 2

31 802 27 2

31 802 61 2

31 802 09 2

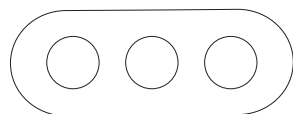

3 éléments 246x100x12mm

31 803 17 2

31 803 27 2

31 803 61 2

31 803 09 2



Adaptateur pour plaques en saillie sans support

Montage direct en surface

30 950 98 2



Adaptateur pour plaques en saillie avec support

Montage boîte d'encastrement

30 951 98 2

GARBY

Collection

Porcelaine

Les plaques requièrent un adaptateur pour un montage en saillie



Coton





Vert ille



Camille

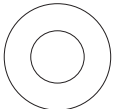
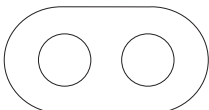
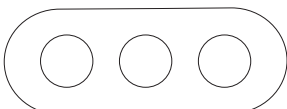

Cru

| | | | | | | |
|---|---|--------------|-------------|------------------------------|-------------|-------------|
|  | 1 élément | Ø 100x12mm | 31 801 85 2 | 31 801 86 2 | 31 801 87 2 | 31 801 88 2 |
|  | 2 éléments | 175x100x12mm | 31 802 85 2 | 31 802 86 2 | 31 802 87 2 | 31 802 88 2 |
|  | 3 éléments | 246x100x12mm | 31 803 85 2 | 31 803 86 2 | 31 803 87 2 | 31 803 88 2 |
|  | Adaptateur pour plaques en saillie sans support | | | Montage direct en surface | | 30 950 98 2 |
|  | Adaptateur pour plaques en saillie avec support | | | Montage boîte d'encastrement | | 30 951 98 2 |

GARBY

Collection

Bois

Les plaques requièrent un adaptateur pour un montage en saillie



Hêtre vieilli



Hêtre couleur miel



Hêtre naturel

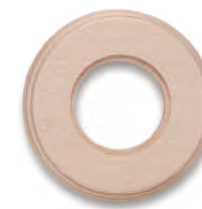

Hêtre sans vernis

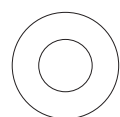

1 élément

Ø 100x12mm

31 801 21 2

31 801 19 2

31 801 81 2

31 801 00 2

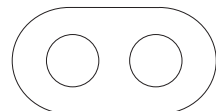

2 éléments

175x100x12mm

31 802 21 2

31 802 19 2

31 802 81 2

31 802 00 2

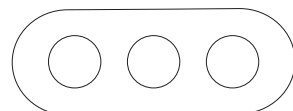

3 éléments

246x100x12mm

31 803 21 2

31 803 19 2

31 803 81 2

31 803 00 2

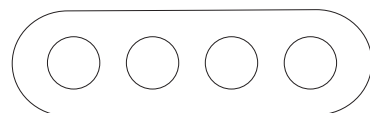

4 éléments

318x100x12mm

31 804 21 2

31 804 19 2

31 804 81 2

31 804 00 2



Adaptateur pour plaques en saillie sans support

Montage direct en surface

30 950 98 2



Adaptateur pour plaques en saillie avec support







Montage boîte d'encastrement

30 951 98 2



GARBY

Collection

| | | | | | | | |
|---|---|----------------|------------------------------|-----|-----|----|---|
|  | Bouchon traversant. ↓ 19 mm pour tube de 16 mm Ø 26mm | Pack 2 uds. | 30 | 938 | 03 | 2 | |
| | | | 30 | 938 | 05 | 2 | |
|  | Fleuron pour lampe | Ø 100x34mm | 30 | 940 | 17 | 2 | |
|  | Boîtier de derivation | Ø 78mm ↓ 46mm | 30 | 399 | 17 | 2 | |
| | | | 30 | 399 | 27 | 2 | |
|  | Boîtier de derivation | Ø 118mm ↓ 53mm | 30 | 401 | 17 | 2 | |
| | | | 30 | 401 | 27 | 2 | |
|  | Boîtier de derivation métallique | Ø 72x46mm | 30 | 399 | 22 | 2 | |
| | | Ø 108x53mm | 30 | 401 | 22 | 2 | |
| | | 175x125x50mm | 30 | 402 | 22 | 2 | |
|  | Tube métallique pour installation en saillie | Ø 16mm | Pack 4 ud x 3 m Total 12m | 30 | 016 | 22 | 2 |
| | | Ø 20mm | | 30 | 020 | 22 | 2 |
| | | Ø 25mm | | 30 | 025 | 22 | 2 |

Finition



Porcelaine blanche



Porcelaine noire



Métal vieilli



Porcelaine marron







Blanc



Marron

GARBY





Collection

| | | | | | | | |
|---|---|--------|--------------|----|-----|----|---|
|  | Agrafe métallique pour fixation de tube | Ø 16mm | Pack 25 uds. | 30 | 716 | 03 | 2 |
| | | Ø 20mm | | 30 | 720 | 03 | 2 |
| | | Ø 25mm | | 30 | 725 | 03 | 2 |
|  | Collier pour fixation de tube | Ø 16mm | Pack 25 uds. | 30 | 816 | 03 | 2 |
| | | Ø 20mm | | 30 | 820 | 03 | 2 |
| | | Ø 25mm | | 30 | 825 | 03 | 2 |
|  | Bague pour assemblage de tubes | Ø 16mm | Pack 10 uds. | 30 | 516 | 22 | 2 |
| | | Ø 20mm | | 30 | 520 | 22 | 2 |
| | | Ø 25mm | Pack 5 uds. | 30 | 525 | 22 | 2 |
|  | Coude pour tube | Ø 16mm | | 30 | 116 | 22 | 2 |
| | | Ø 20mm | | 30 | 120 | 22 | 2 |
| | | Ø 25mm | | 30 | 125 | 22 | 2 |
|  | Courbe 90° pour tube | Ø 16mm | | 30 | 416 | 22 | 2 |
| | | Ø 20mm | | 30 | 420 | 22 | 2 |
| | | Ø 25mm | | 30 | 425 | 22 | 2 |

Pour une installation en saillie complète, les bagues sont nécessaires pour assembler la courbe au tube.

GARBY

Collection

| | | | | | | |
|---|--|--------|----|-----|----|---|
|  | Dérivateur T pour tube | Ø 16mm | 30 | 616 | 22 | 2 |
| | | Ø 20mm | 30 | 620 | 22 | 2 |
| | | Ø 25mm | 30 | 625 | 22 | 2 |
|  | Adaptateur pour tube de Ø20mm sur socle | | 30 | 007 | 03 | 2 |
|  | Rehausseur Dimbler pour socle tube Garby | | 60 | 952 | 03 | 2 |
|  | Base isolante pour mécanismes de surface | | 30 | 952 | 02 | 2 |
|  | Spray réparateur de peinture 400 ml | | 30 | 001 | 22 | 2 |

Acabado
Finish
Finition

22 Metal envejecido
Aged metal
Métal vieilli

05 Blanco
White
Blanc

03 Marrón
Brown
Marron

DIMBLER
Collection

Fontini



DIMBLER

Collection

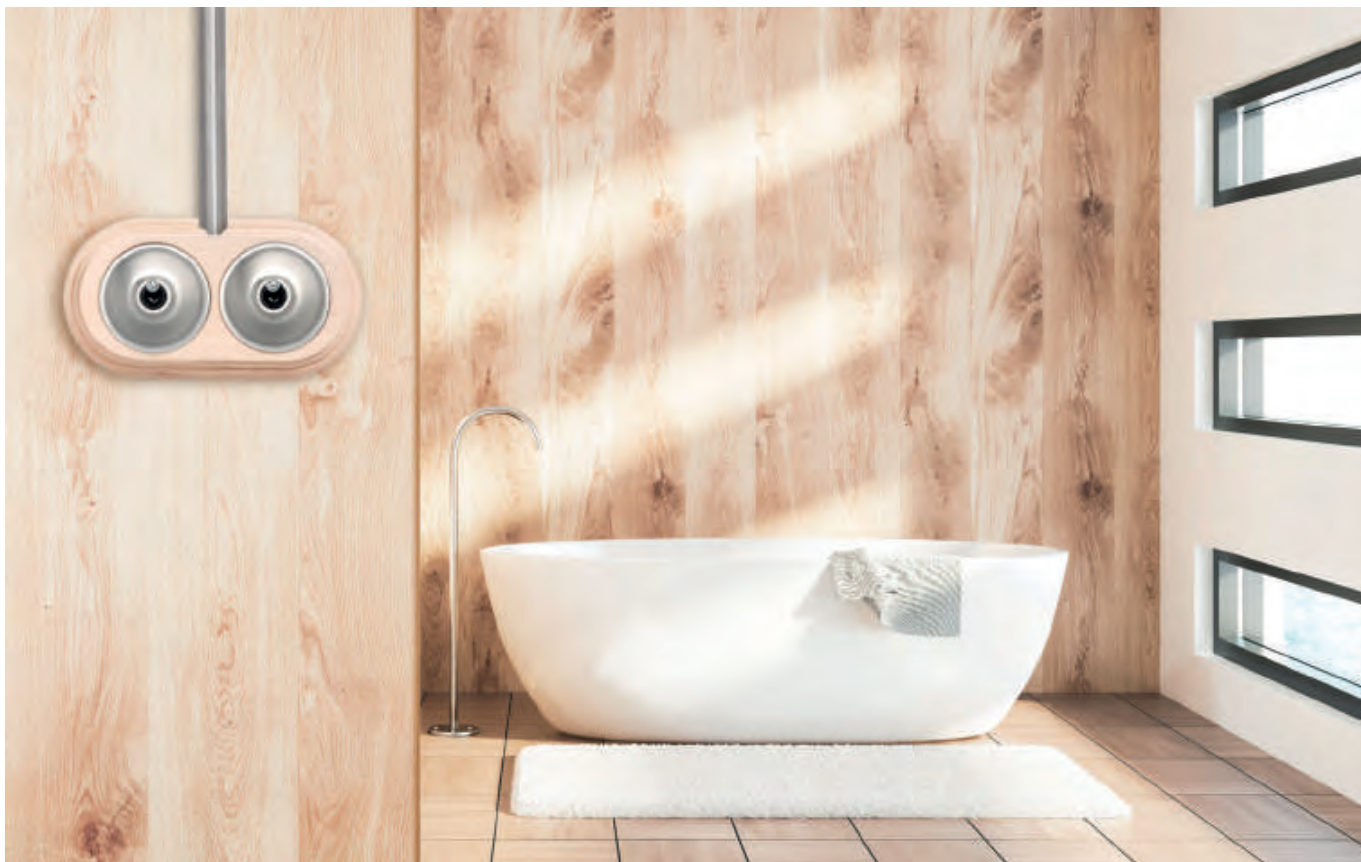

Mécanismes compatibles avec les plaques et accessoires des Collection Garby

DIMBLER

Collection

Porcelaine avec passe-câble



41



42



43



44



45

Porcelaine sans passe-câble



61

Manette nickel noire



62

Manette cuivre brillante



63

Manette dorée brillante



64

Manette chromée brillante



65

Manette laiton vieillie

DIMBLER

Collection

Porcelaine avec passe-câble



21



22



23



24



25

Porcelaine sans passe-câble



31

Manette nickel noire



32

Manette cuivre brillante



33

Manette dorée brillante



34

Manette chromée brillante



35

Manette laiton vieillie

DIMBLER

Collection



Va-et-vient

10AX - 250V~

60

308

--

2

Permutateur

10AX - 250V~

60

304

--

2

Interrupteur bipolaire

10AX - 250V~

60

314

--

2

Bouton poussoir à manette

10AX - 250V~

60

312

--

2

DIMBLER

Collection

Métal avec passe-câble



52



70



81



72



51

Métal sans passe-câble



59

Carcasse dorée satinée
Manette dorée brillante



71

Carcasse bronze ancien
Manette laiton vieillie



68

Carcasse chromée brillante
Manette chromée brillante



82

Carcasse cuivre brillante
Manette cuivre brillante



56

Carcasse nickel satiné
Manette chromé brillante

DIMBLER

Collection

Métal avec passe-câble



74



75



77



78



79

Métal sans passe-câble



84

Carcasse dorée satinée
Manette dorée brillante



85

Carcasse bronze ancien
Manette laiton vieillie



87

Carcasse chromée brillante
Manette chromée brillante



88

Carcasse cuivre brillante
Manette cuivre brillante



89

Carcasse nickel satiné
Manette chromée brillante

DIMBLER

Collection



Va-et-vient

10AX - 250V~

60

308

--

2

Permutateur

10AX - 250V~

60

304

--

2

Interrupteur bipolaire

10AX - 250V~

60

314

--

2

Bouton poussoir à manette

10AX - 250V~
24V DC

60

312

--

2



Bouton poussoir

60

310

--

2

GARBY Colonial
Collection

Fontini



GARBY Colonial Collection

Manettes et vis

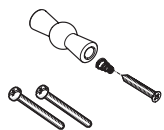

Mécanismes

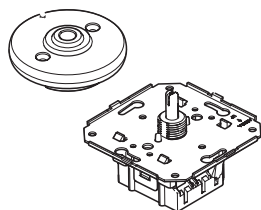

Plaques

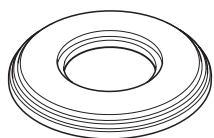

GARBY Colonial

Collection

















Manettes. Porcelaine

| | | | | | | | |
|---|---|---|-------------|----|-----|----|---|
|  |  | Manette rotative porcelaine blanche. Vis patinées | Pack 1 ud. | 30 | 967 | 17 | 1 |
| | | | Pack 5 uds. | 30 | 967 | 17 | 7 |
|  |  | Manette rotative porcelaine noire. Vis noire | Pack 1 ud. | 30 | 967 | 27 | 1 |
| | | | Pack 5 uds. | 30 | 967 | 27 | 7 |
|  |  | Manette rotative porcelaine retro blanche. Vis patinées | Pack 1 ud. | 30 | 930 | 17 | 1 |
| | | | Pack 5 uds. | 30 | 930 | 17 | 7 |
|  |  | Manette rotative porcelaine retro noire. Vis noire | Pack 1 ud. | 30 | 930 | 27 | 1 |
| | | | Pack 5 uds. | 30 | 930 | 27 | 7 |

GARBY Colonial

Collection

Manettes. Bois / Laitón

| | | | | | | | |
|---|---|---|-------------|----|-----|----|---|
|  |  | Manette rotative hêtre couleur miel: Vis patinées | Pack 1 ud. | 30 | 967 | 19 | 1 |
| | | | Pack 5 uds. | 30 | 967 | 19 | 7 |
|  |  | Manette rotative hêtre vieilli . Vis patinées | Pack 1 ud. | 30 | 967 | 21 | 1 |
| | | | Pack 5 uds. | 30 | 967 | 21 | 7 |
|  |  | Manette rotative hêtre naturel. Vis patinées | Pack 1 ud. | 30 | 967 | 81 | 1 |
| | | | Pack 5 uds. | 30 | 967 | 81 | 7 |
|  |  | Manette rotative hêtre sans vernis. Vis patinées | Pack 1 ud. | 30 | 967 | 00 | 1 |
| | | | Pack 5 uds. | 30 | 967 | 00 | 7 |
|  |  | Manette rotative cuivre brillant. Vis cuivre | Pack 1 ud. | 30 | 967 | 31 | 1 |
| | | | Pack 5 uds. | 30 | 967 | 31 | 7 |
|  |  | Manette rotative nickel noir. Vis noire | Pack 1 ud. | 30 | 967 | 30 | 1 |
| | | | Pack 5 uds. | 30 | 967 | 30 | 7 |
|  |  | Manette rotative laiton vieilli. Vis patinées | Pack 1 ud. | 30 | 967 | 83 | 1 |
| | | | Pack 5 uds. | 30 | 967 | 83 | 7 |
|  |  | Manette rotative chrome. Vis chromées | Pack 1 ud. | 30 | 967 | 26 | 1 |
| | | | Pack 5 uds. | 30 | 967 | 26 | 7 |

GARBY Colonial

Collection

Mecanismes



| | | | | | |
|---|--------------|----|-----|----|---|
| Interrupteur unipolaire | 10AX - 250V~ | 31 | 306 | -- | 1 |
| Va-et-vient | 10AX - 250V~ | 31 | 308 | -- | 1 |
| Permutateur | 10AX - 250V~ | 31 | 304 | -- | 1 |
| Interrupteur bipolaire | 10AX - 250V~ | 31 | 314 | -- | 1 |
| Mécanisme pour volets roulants (pour moteurs 1,66A) | 10A - 250V~ | 31 | 342 | -- | 1 |

17



27



GARBY Colonial

Collection

Mecanismes



Double interrupteur

10AX-250V~

31

300

--

1

Double va-et-vient

10AX-250V~

31

302

--

1

17



27



GARBY Colonial

Collection

Mecanismes



Poussoir rotatif

SALIDA / OUTPUT / SORTIE

Position de repos

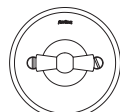

OFF

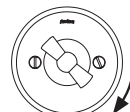

ON

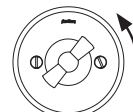

ON

31

328

--

1

Double poussoir rotatif

SALIDA / OUTPUT / SORTIE

Position de repos

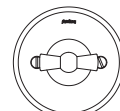

OFF

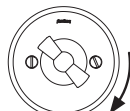

ON 1

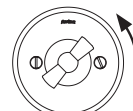

ON 2

31

344

--

1



Bouton poussoir

10AX - 250V~
24V DC

31

310

--

2

Bouton poussoir temporisateur

10AX - 250V~

31

316

--

2



Double bouton poussoir

10AX - 250V~
24V DC

31

343

--

2

17



27



GARBY Colonial

Collection

Prise de courant



Prise de courant avec terre
Carcasse en porcelaine

16A - 250V~

31 208 -- 2

Produits électroniques



Variateur universel 230 V 4-400 W

Permet de régler les lampes à incandescence, halogènes ou LED réglables.
(Il n'est pas possible de mélanger différentes charges dans un même circuit).

Gamme de variation : 4-400 W (lampes à incandescence, halogènes HV et LV)
4-100 W (LED réglable)

31 330 -- 2

Variateur pour moteurs rotatif

Gamme de variation : 40-250W

31 331 -- 2



Chargeur USB double

Permet le chargement d'appareils tels que les smartphones et les tablettes.

Deux sorties de charge jusqu'à un maximum de 2,6 A.
Charge rapide avec un seul appareil connecté et charge lente avec deux appareils connectés :

- 1 x 2,6 A (une sortie connectée)
- 2 x 1,3 A (2 sorties connectées)

31 765 -- 2

17



27



GARBY Colonial

Collection

Prises TV

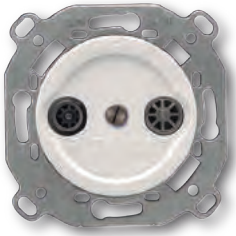

Prise signal RTV-SAT égalisée

Prise unique

| | | | |
|----|-----|----|---|
| 35 | 712 | -- | 2 |
|----|-----|----|---|

Prise intermédiaire A

| | | | |
|----|-----|----|---|
| 35 | 713 | -- | 2 |
|----|-----|----|---|

Prise intermédiaire B

| | | | |
|----|-----|----|---|
| 35 | 714 | -- | 2 |
|----|-----|----|---|

Prise finale

| | | | |
|----|-----|----|---|
| 35 | 711 | -- | 2 |
|----|-----|----|---|



Couvercle R-TV

| | | | |
|----|-----|----|---|
| 35 | 715 | -- | 2 |
|----|-----|----|---|



GARBY Colonial Collection

Prises VDI



Prise simple

RJ12

31 701 -- 2

RJ45 CAT 6

31 702 -- 2

RJ12 + RJ45 CAT 6A

31 760 -- 2



GARBY Colonial

Collection

Prises VDI



Double prise

RJ12

31 706 -- 2

RJ45 CAT6

31 707 -- 2

RJ12 + RJ45 CAT 6

31 708 -- 2



Double prise

RJ45 CAT 6A blindé





31 761 -- 2



GARBY Colonial

Collection

Prises VDI



| | | | | | | |
|---|-----------------|-----------------------------------|----|-----|----|---|
|  | Double prise * | HDMI | 31 | 726 | -- | 2 |
|  | Double prise ** | HDMI + USB | 31 | 743 | -- | 2 |
|  | Double prise * | HDMI + RJ45 CAT 6 | 31 | 728 | -- | 2 |
|  | Double prise ** | USB Adaptateur femelle-femelle | 31 | 729 | -- | 2 |
|  | Double prise ** | USB + RJ45 CAT 6 | 31 | 719 | -- | 2 |



* Boîtier à encastrer spécial
 ** USB prise n'est pas un chargeur USB

GARBY Colonial

Collection

| | | | | | | |
|---|---|----------------|------------|------------|-----------|----------|
|  | <p>Potentiomètre pour réglage du volume</p> | <p>31</p> | <p>924</p> | <p>--</p> | <p>2</p> | |
|  | <p>Couvercle aveugle</p> | <p>31</p> | <p>656</p> | <p>--</p> | <p>2</p> | |
|  | <p>Sortie de câbles</p> | <p>Ø 8.5mm</p> | <p>31</p> | <p>927</p> | <p>--</p> | <p>2</p> |



GARBY Colonial

Collection





Hêtre vieilli

Hêtre couleur miel

Hêtre naturel

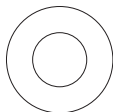
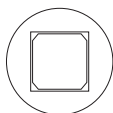
Hêtre sans vernis

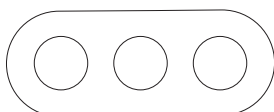
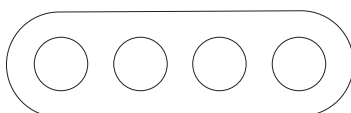
| | | | | | | |
|---|-----------------|--------------|-------------|-------------|-------------|-------------|
|  | 1 élément | Ø 100x12mm | 31 801 21 2 | 31 801 19 2 | 31 801 81 2 | 31 801 00 2 |
|  | 1 élément carré | Ø 100x12mm | 31 821 21 2 | 31 821 19 2 | 31 821 81 2 | 31 821 00 2 |
|  | 2 éléments | 175x100x12mm | 31 802 21 2 | 31 802 19 2 | 31 802 81 2 | 31 802 00 2 |
|  | 3 éléments | 246x100x12mm | 31 803 21 2 | 31 803 19 2 | 31 803 81 2 | 31 803 00 2 |
|  | 4 éléments | 318x100x12mm | 31 804 21 2 | 31 804 19 2 | 31 804 81 2 | 31 804 00 2 |

A utiliser avec les références 37 721..., 37 722..., 37 750...

GARBY Colonial

Collection



Porcelaine
blanche



Porcelaine
noire



Porcelaine
décor



Porcelaine
craquelé

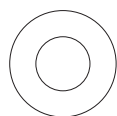

1 élément Ø 100x12mm

31 801 17 2

31 801 27 2

31 801 61 2

31 801 09 2

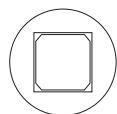

1 élément carré Ø 100x12mm

31 821 17 2

31 821 27 2

31 821 61 2

31 821 09 2



2 éléments 175x100x12mm

31 802 17 2

31 802 27 2

31 802 61 2

31 802 09 2

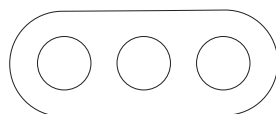

3 éléments 246x100x12mm

31 803 17 2

31 803 27 2

31 803 61 2

31 803 09 2

Venezia
Collection

Fontini



Venezia

Collection

Mécanismes

Serie 65

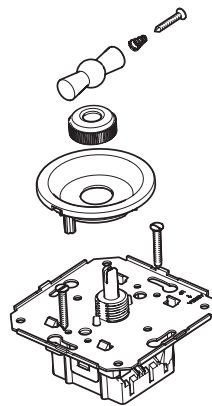
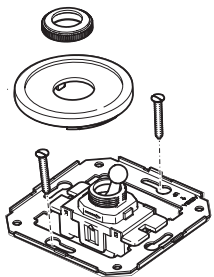

Serie 35



Plaques

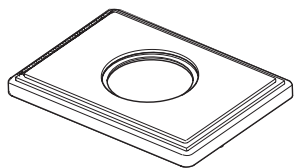

Venezia

Collection



30
Manette dorée



59
Manette bronze ancien



26
Manette chrome brillant



54
Manette dorée



57
Manette bronze ancien



52
Manette chrome brillant

Venezia

Collection



Interrupteur unipolaire

10AX - 250V~

65

306

--

1

Va-et-vient

10AX - 250V~

65

308

--

1

Permutateur

10AX - 250V~

65

304

--

1

Interrupteur bipolaire

10AX - 250V~

65

314





--

1

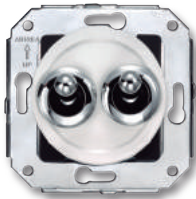

Venezia

Collection

| | | | | | | |
|---|--|--------------|----|-----|----|---|
|  | Double interrupteur | 10AX - 250V~ | 65 | 300 | -- | 2 |
| | Double va-et-vient | 10AX - 250V~ | 65 | 302 | -- | 2 |
|  | Bouton poussoir | 10A - 250V | 65 | 312 | -- | 2 |
|  | Double bouton poussoir | 10A - 250V~ | 65 | 345 | -- | 2 |
|  | Double poussoir pour volets roulants (pour moteurs 1,66A) | 10A - 250V~ | 65 | 342 | -- | 2 |



Venezia

Collection

| | | | | | | |
|---|--|-------------|----|-----|----|---|
|  | Bouton poussoir | 10A - 250V | 65 | 312 | -- | 2 |
|  | Double bouton poussoir | 10A - 250V~ | 65 | 345 | -- | 2 |
|  | Double poussoir pour volets roulants (pour moteurs 1,66A) | 10A - 250V~ | 65 | 342 | -- | 2 |



Venezia

Collection



30

Manette dorée



16

Manette hêtre couleur miel



17

Manette porcelaine blanche



59

Manette bronze ancien



25

Manette nickel satiné



23

Manette porcelaine rétro blanche

Venezia

Collection



54

Manette dorée



57

Manette bronze ancien



52

Manette nickel satiné

Venezia

Collection

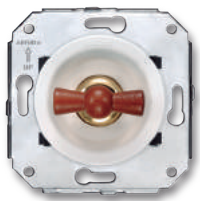

Interrupteur

10AX - 250V~

35

306

--

2

Va-et-vient

10AX - 250V~

35

308

--

2

Permutateur

10AX - 250V~

35

304

--

2

Interrupteur bipolaire

10AX - 250V~

35

314

--

2

Mécanisme pour volets roulants
(pour moteurs 1,66A)

10A - 250V~

35

342

--

2

30



16



17



59



25



23



54



57



52



Venezia

Collection

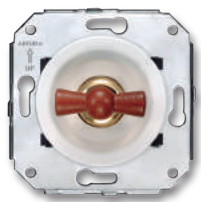

Double interrupteur

10AX - 250V~

35

300

--

2

Double va-et-vient

10AX - 250V~

35

302

--

2



Venezia

Collection

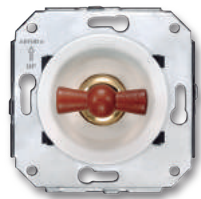

Bouton rotatif
10AX - 250V~

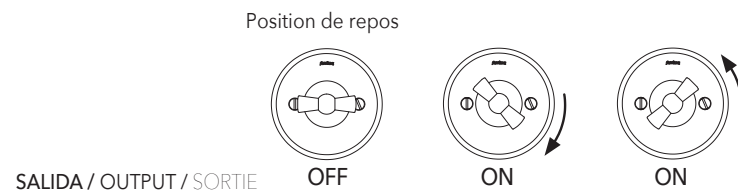

35 328 -- 2



Double bouton rotatif
10AX - 250V~

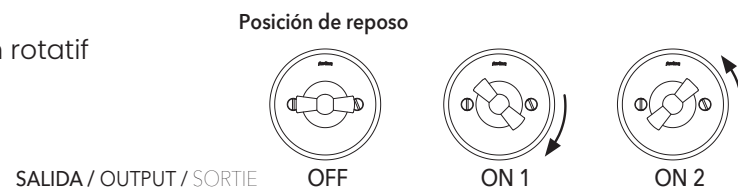

35 344 -- 2

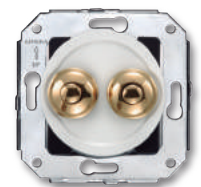

Bouton poussoir 10AX - 250V~

Acabados: Finishes: Finitions: 30-25-59-54-57-52-26-58

35 310 -- 2

Bouton poussoir temporisateur 10AX - 250V~
30 sec. à 10 min. Incandescence et halogène.

Acabados: Finishes: Finitions: 30-25-59-54-57-52-26-58

35 316 -- 2

Double bouton poussoir 10AX - 250V~

Acabados: Finishes: Finitions: 30-25-59-54-57-52-26-58

35 343 -- 2



Venezia

Collection

Prises de courant



Prise de courant sans terre

16A - 250V~

35

209

--

2



Prise de courant avec terre

16A - 250V~

35

208

--

2

Variateur universel



Variateur universel 230 V 4-400 W

Permet de régler les lampes à incandescence, halogènes ou LED réglables.
(Il n'est pas possible de mélanger différentes charges dans un même circuit).

Gamme de variation : 4-400 W (lampes à incandescence, halogènes HV et LV)
4- 100 W (lampes LED réglables)

35

330

--

2

05



03



Venezia

Collection



Prise signal RTV-SAT égalisée

Prise unique

35 712 -- 2

Prise intermédiaire A

35 713 -- 2

Prise intermédiaire B

35 714 -- 2

Prise finale

35 711 -- 2



Couvercle

35 715 -- 2



Venezia

Collection



Double prise

RJ12

35

706

--

2

RJ45 CAT6

35

707

--

2

RJ12 + RJ45 CAT6

35

708

--

2



RJ45 CAT6A

35

761

--

2



Double prise

HDMI

35

726

--

2

05







03



Venezia

Collection

| | | | | | | |
|---|---|----------------------------|----|-----|----|---|
|  | Double prise | HDMI + USB | 35 | 743 | -- | 2 |
|  | Double prise | HDMI + RJ45 CAT6 | 35 | 728 | -- | 2 |
|  | Double prise USB USB prise n'est pas un chargeur USB | Adaptateur femelle-femelle | 35 | 729 | -- | 2 |
|  | Double prise | USB+RJ45 CAT6 | 35 | 719 | -- | 2 |
|  | Prise audio | RCA | 37 | 907 | -- | 2 |

05







03



Venezia

Collection





| | | | | | | |
|---|---|---|----|-----|----|---|
|  | Mécanisme pour cartes avec indicateur lumineux. Interrupteur - Va-et-vient | 1 microrupteur 6A - 250V~ | 37 | 935 | -- | 2 |
| | | 2 microrupteurs 6A - 250V~ | 37 | 936 | -- | 2 |
|    | Balise lumineuse, blanche - verte - rouge | 230V~ | 35 | 755 | -- | 2 |
| | | 12/24V DC | 35 | 756 | -- | 2 |
|  | Thermostat pour chauffage sol radiant. * | Avec sonde. | 37 | 721 | 05 | 2 |
| | | Thermostat chauffage température ambiante * | 37 | 722 | 05 | 2 |

* Monter avec plaque 35-821-..



Venezia

Collection

| | | | | | | |
|---|-----------------------------------|-------------|----|-----|----|---|
|  | Détecteur de présence et son 180° | | 37 | 750 | -- | 2 |
|  | Interrupteur à clés | | 35 | 906 | -- | 2 |
|  | Hautparleur pour boîtier standard | 2W 16Ω | 35 | 926 | -- | 2 |
|  | Prise pour hautparleur | S/DIN 41429 | 35 | 905 | -- | 2 |
|  | Sonette intermittente | 220V 80 dB | 35 | 390 | -- | 2 |



* Monter avec plaque 35-821-..

Venezia

Collection



Sortie de câbles

35 927 - 2

Finitions: 30-59-25-54-57-52-26-58



Couvercle aveugle

35 656 -- 2



Venezia

Oval



Haya color nogal
Beech walnut colored
Hêtre couleur noyer



Sapelly
Sapelly
Sapelly



Haya color roble
Beech oak colored
Hêtre couleur chêne



Haya sin barniz
Beech without varnish
Hêtre sans vernis



Haya lacado blanco
Beech white lacquered
Hêtre laqué blanc

| | | | | | |
|---|-------------|-------------|-------------|-------------|-------------|
| 1 elemento 1 element 1 élément | 35 801 20 2 | 35 801 16 2 | 35 801 15 2 | 35 801 00 2 | 35 801 05 2 |
| 1 elemento cuadrado* 1 square element 1 élément carré | 35 821 20 2 | 35 821 16 2 | 35 821 15 2 | 35 821 00 2 | 35 821 05 2 |
| 2 elementos 2 elements 2 éléments | 35 802 20 2 | 35 802 16 2 | 35 802 15 2 | 35 802 00 2 | 35 802 05 2 |
| 3 elementos 3 elements 3 éléments | 35 803 20 2 | 35 803 16 2 | 35 803 15 2 | 35 803 00 2 | 35 803 05 2 |
| 4 elementos 4 elements 4 éléments | 35 804 20 2 | 35 804 16 2 | 35 804 15 2 | 35 804 00 2 | 35 804 05 2 |

Venezia

Clásica

Venezia

Carré



Sapelly

Hêtre sans vernis

| | | |
|-----------------|-------------|-------------|
| 1 élément | 36 801 16 2 | 36 801 00 2 |
| 1 élément carré | 36 821 16 2 | 36 821 00 2 |
| 2 éléments | 36 802 16 2 | 36 802 00 2 |
| 3 éléments | 36 803 16 2 | 36 803 00 2 |
| 4 éléments | 36 804 16 2 | 36 804 00 2 |



Sapelly

Hêtre sans vernis

| | |
|-------------|-------------|
| 36 811 16 2 | 36 811 00 2 |
| 36 831 16 2 | 36 831 00 2 |
| 36 812 16 2 | 36 812 00 2 |
| 36 813 16 2 | 36 813 00 2 |
| 36 814 16 2 | 36 814 00 2 |

Venezia

Laiton



Doré





Bronze ancien

Nickel satiné

| | | Doré | Bronze ancien | Nickel satiné |
|---|-------------|-------------|---------------|---------------|
| 1 elemento 1 element 1 élément | 125x91x12mm | 39 801 50 2 | 39 801 53 2 | 39 801 51 2 |
| 1 elemento cuadrado* 1 square element 1 élément carré | 125x91x12mm | 39 821 50 2 | 39 821 53 2 | 39 821 51 2 |
| 2 elementos 2 elements 2 éléments | 181x91x12mm | 39 802 50 2 | 39 802 53 2 | 39 802 51 2 |
| 3 elementos 3 elements 3 éléments | 253x91x12mm | 39 803 50 2 | 39 803 53 2 | 39 803 51 2 |
| 4 elementos 4 elements 4 éléments | 324x91x12mm | 39 804 50 2 | 39 804 53 2 | 39 804 51 2 |







Boîtes métalliques

| | | | | | | | |
|---|-----------------------------|---------------|--------------------------|----|-----|----|---|
|  | Boîte de dérivation | | 86x86x40mm* | 37 | 400 | 51 | 2 |
|  | Boîte de dérivation | | 86x160x40mm* | 37 | 399 | 51 | 2 |
|  | Boîte de dérivation | Rectangulaire | 175x125x50mm | 30 | 402 | 51 | 2 |
|  | Boîte saillie métal vielli | 2 éléments | installation horizontale | 35 | 408 | 22 | 2 |
| | | | installation verticale | 35 | 409 | 22 | 2 |
|  | Boîte saillie nickel satiné | 2 éléments | installation horizontale | 35 | 408 | 51 | 2 |
| | | | installation verticale | 35 | 409 | 51 | 2 |

*1 entrée de tube 16mm

Compléments





| | | | | | | | |
|---|--|--------------------|-------------------|-----------|------------|-----------|----------|
|  | <p>Pulsador timbre Pushbutton switch Bouton poussoir</p> | <p>10A - 250V~</p> | <p>Pack 1 ud.</p> | <p>14</p> | <p>310</p> | <p>50</p> | <p>2</p> |
|  | <p>Pulsador timbre Pushbutton switch Bouton poussoir</p> | <p>10A - 250V~</p> | <p>Pack 1 ud.</p> | <p>14</p> | <p>310</p> | <p>51</p> | <p>2</p> |
|  | <p>Pulsador timbre Pushbutton switch Bouton poussoir</p> | <p>10A - 250V~</p> | <p>Pack 1 ud.</p> | <p>14</p> | <p>010</p> | <p>02</p> | <p>2</p> |
|  | | | | <p>14</p> | <p>010</p> | <p>50</p> | <p>2</p> |
|  | | | | <p>14</p> | <p>010</p> | <p>51</p> | <p>2</p> |

02 Noir

50 Doré

51 Niquelé

Compléments

| | | | | | | |
|---|---|------------|----|-----|----|---|
|  | <p>Incandescencia - halógenas 230V~ 40-500W Incandescent - halogen bulbs 230V~ 40-500W Incandescence - halogènes 230V~ 40-500W</p> <p>Transformador mecánico 40-500W Mechanical transformer 40-500W Transformateur mécanique 40-500W</p> | 51x42x15mm | 37 | 346 | 00 | 0 |
|  | <p>Incandescencia - halógenas 230V~ 60-900W Incandescent - halogen bulbs 230V~ 60-900W Incandescence - halogènes 230V~ 60-900W</p> <p>Transformador mecánico 60-900W Mechanical transformer 60-900W Transformateur mécanique 60-900W</p> | 51x51x29mm | 37 | 347 | 00 | 0 |
|  | <p>LED 1-200W</p> | 53x51x23mm | 37 | 365 | 00 | 0 |
|  | <p>LED 1-100W Incandescencia - halógenas 230V~ 1-400W Incandescent - halogen bulbs 230V~ 1-400W Incandescence-halogènes 230V~ 1-400W</p> <p>Transformador electrónico-electromecánico 1-300W Electronic-electromechanical transformer 1-300W Transformateur électronique-électromécanique 1-300W</p> <p>Lámparas fluorescentes compactas (CFL) 1-100W Compact fluorescent lamps (CFL) 1-100W Lampes fluorescentes compactes (CFL) 1-100W</p> | 47x42x21mm | 37 | 371 | 00 | 0 |
|  | <p>0-10V / 1-10V máx. 50mA</p> | 54x52x23mm | 37 | 372 | 00 | 0 |

Types d'installations

Fontini



Types d'installations

GARBY / DIMBLER

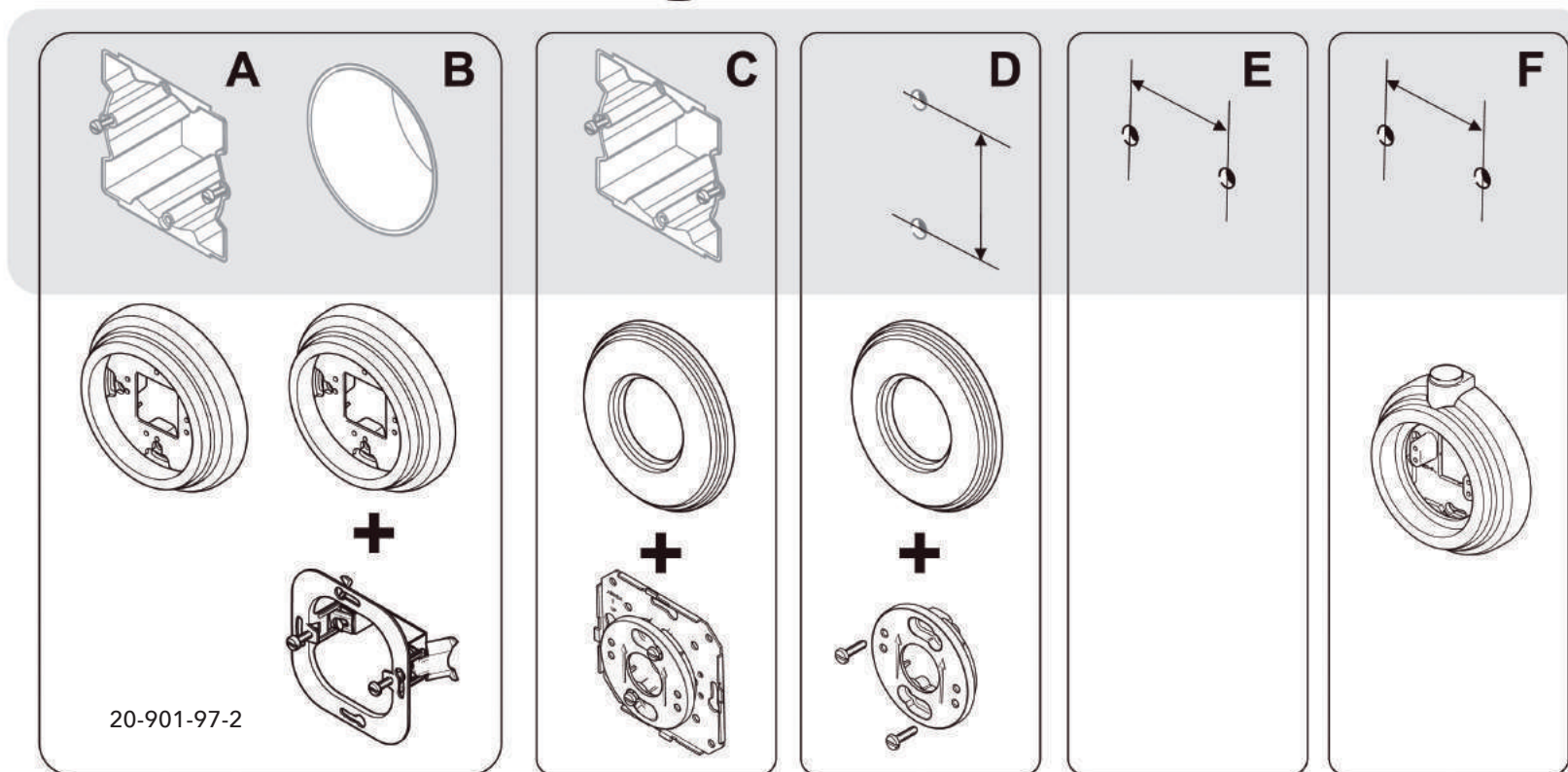
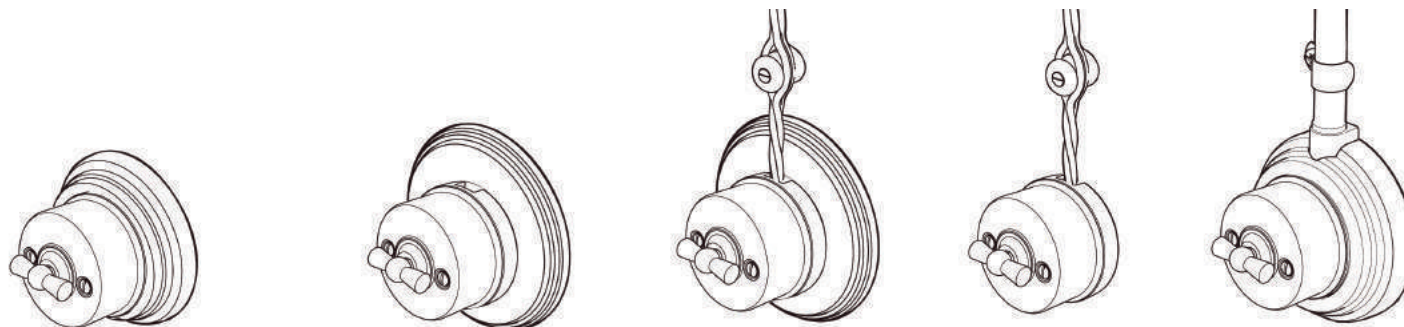

Types d'installations

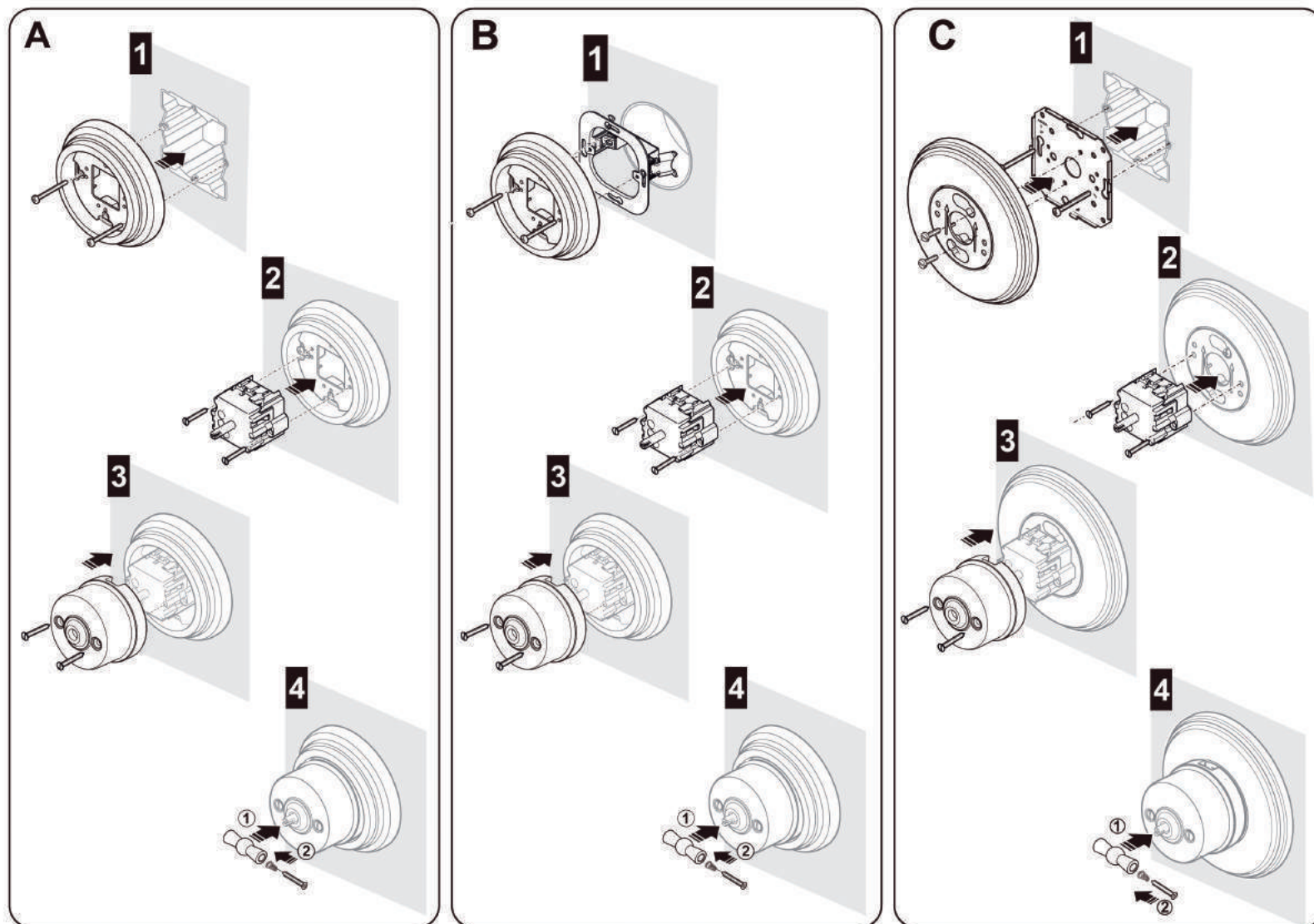

Types d'installations

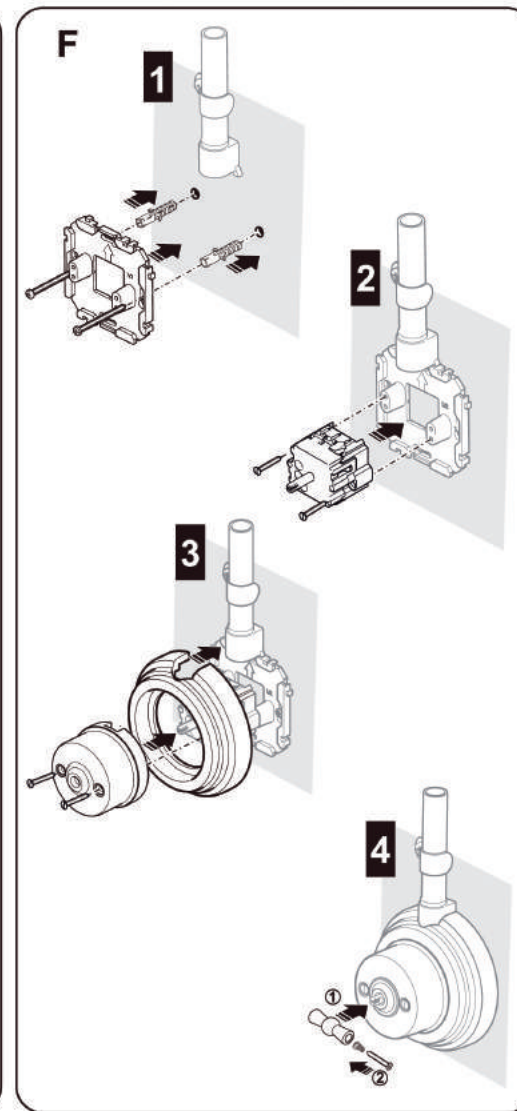
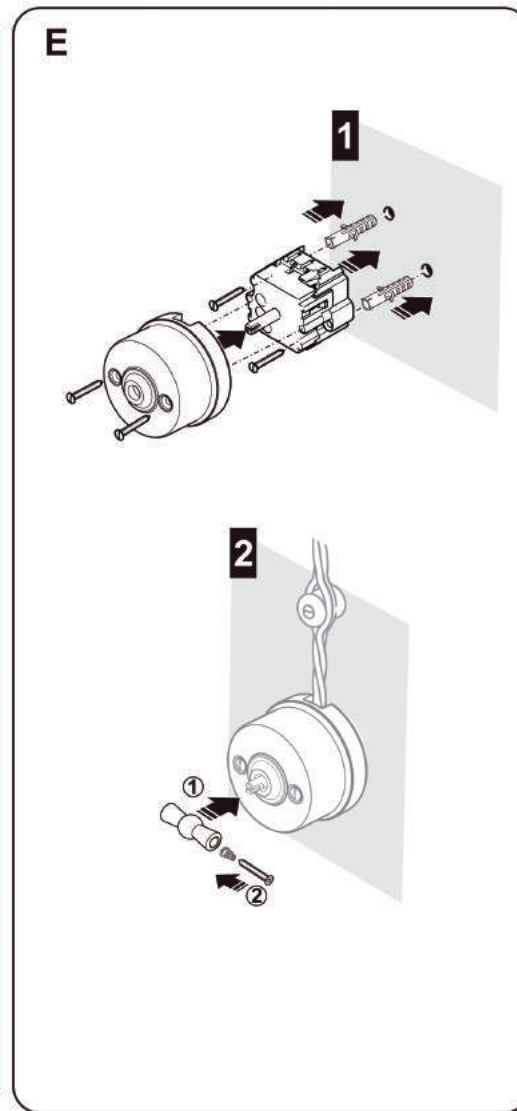
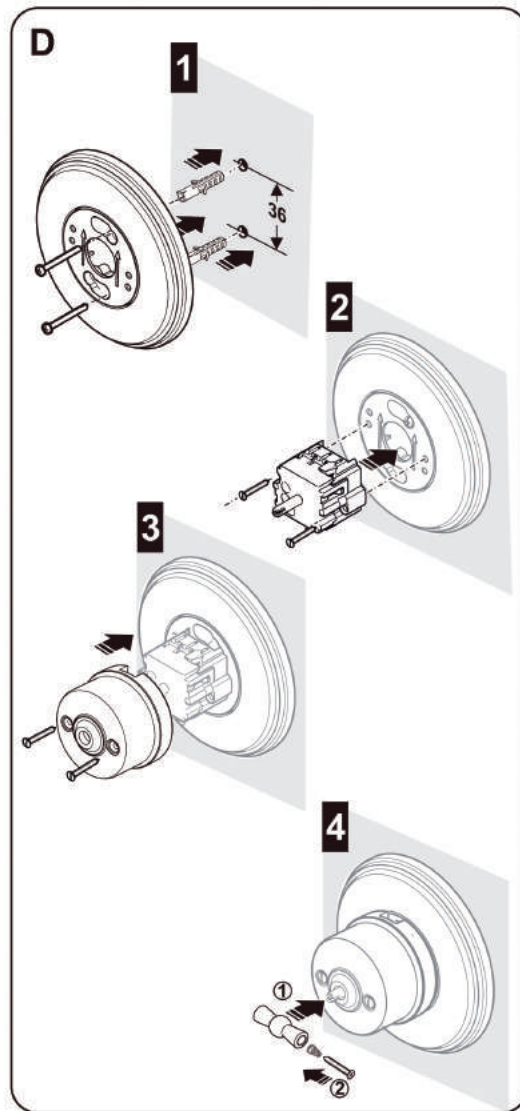

Types d'installations

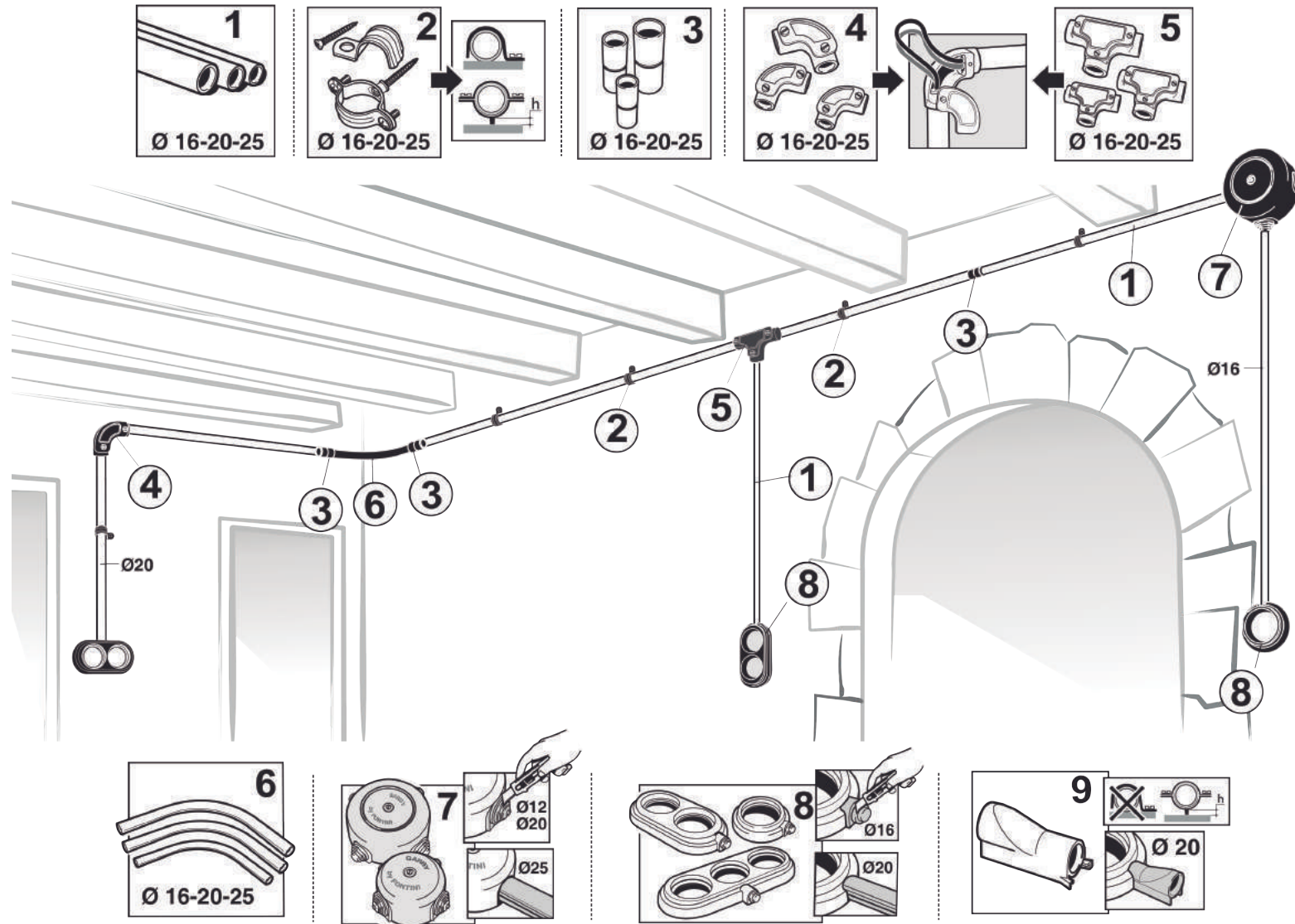

Types d'installations

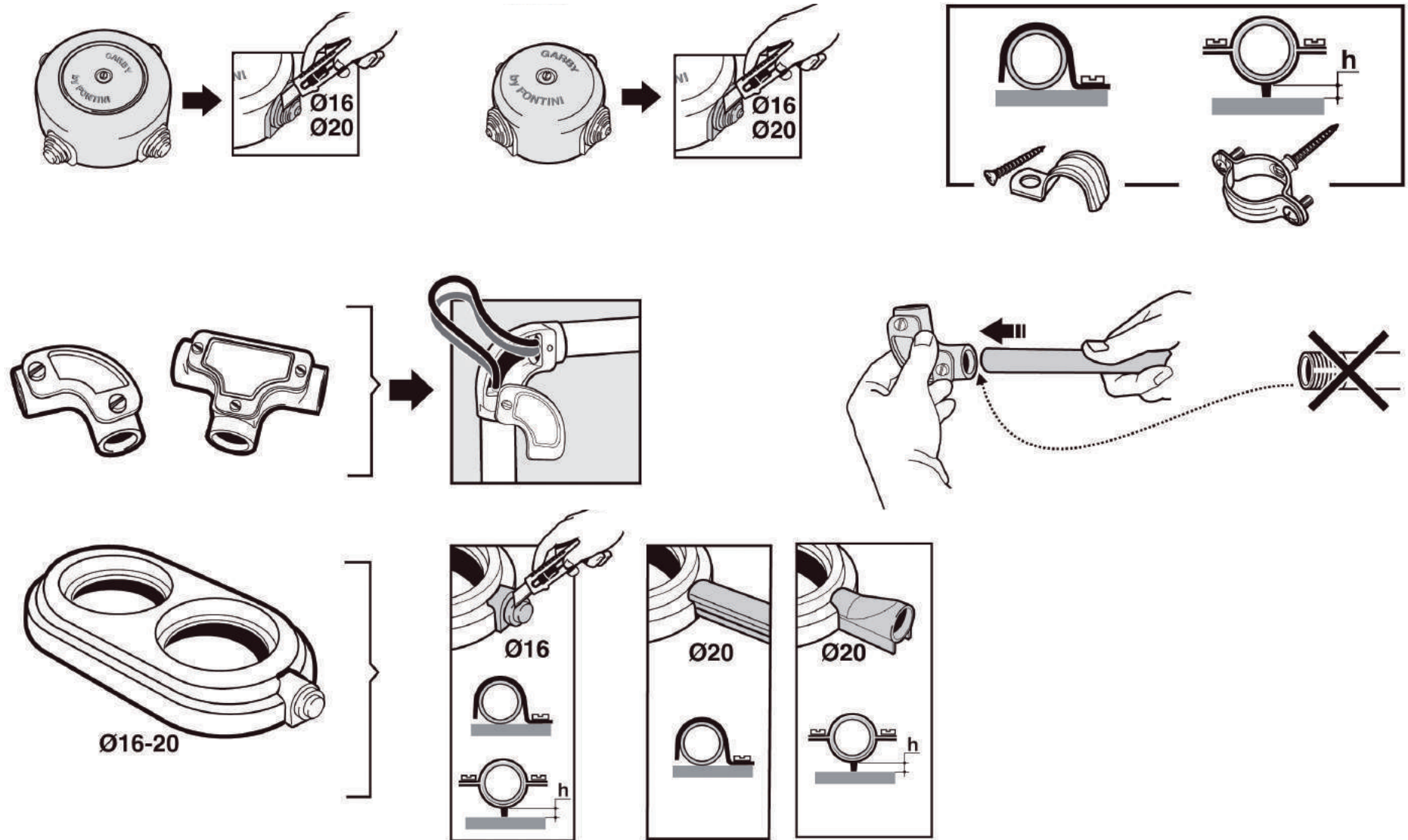

Schémas de connexion

GARBY

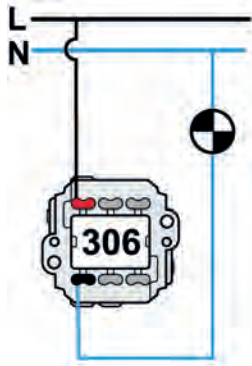

Interrupteur

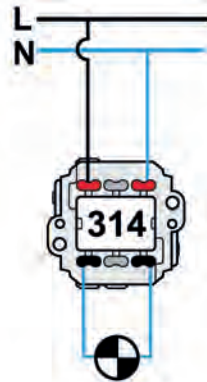

Interrupteur bipolaire

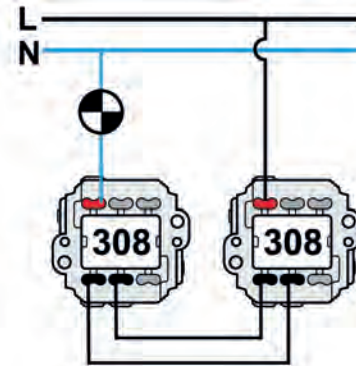

Va-et-vient

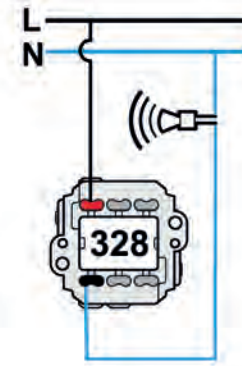

Bouton-poussoir rotatif

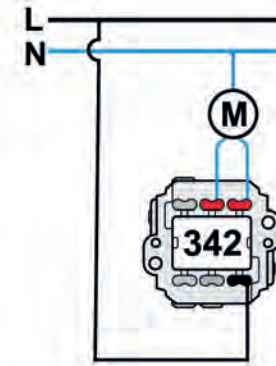

Mécanisme volets roulants

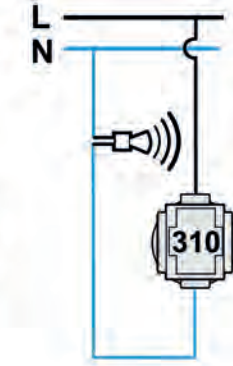

Bouton-poussoir

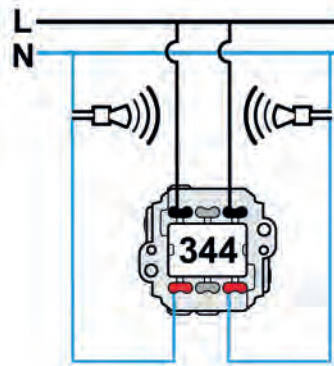

Double bouton rotatif

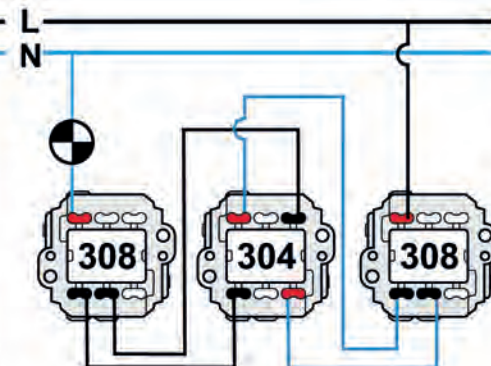

Permutateur

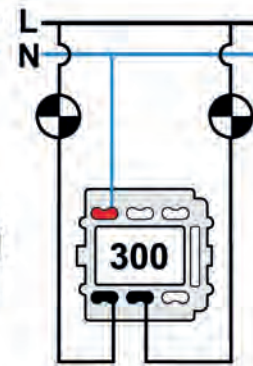

Double interrupteur unipolaire

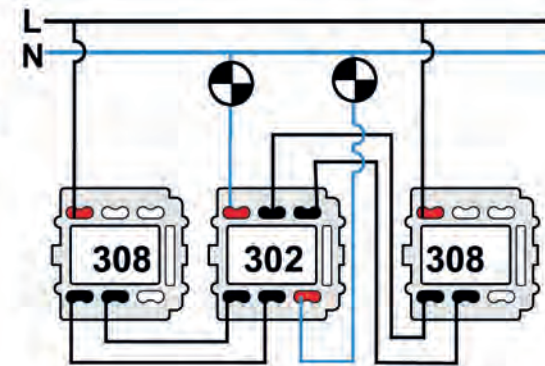

Double va-et-vient

Schémas de connexion

DIMBLER / VENEZIA

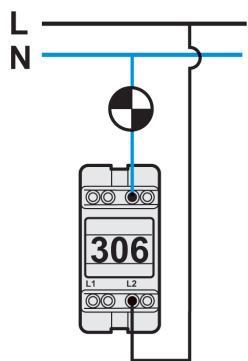

Interrupteur

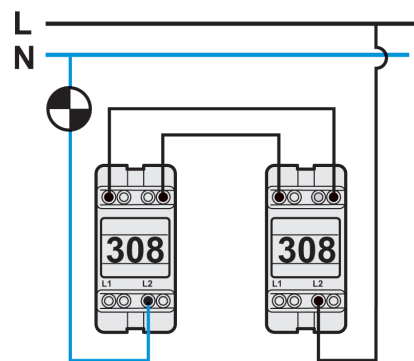

Va-et-vient

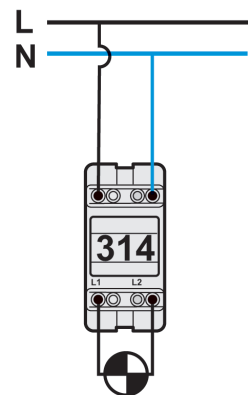

Interrupteur bipolaire

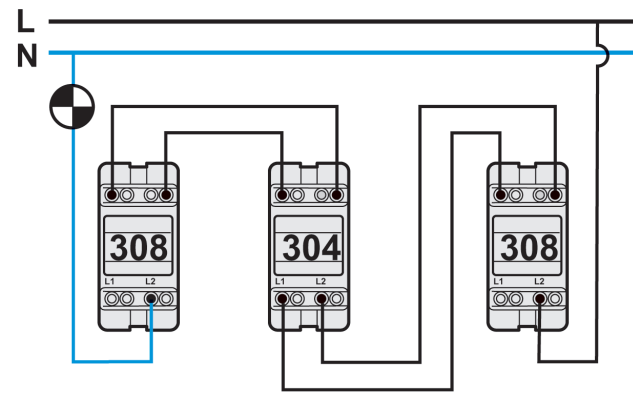

Permutateur

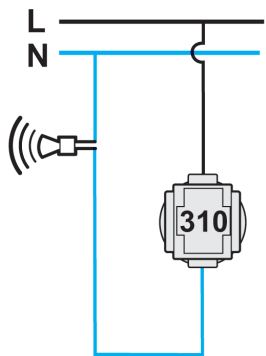

Bouton

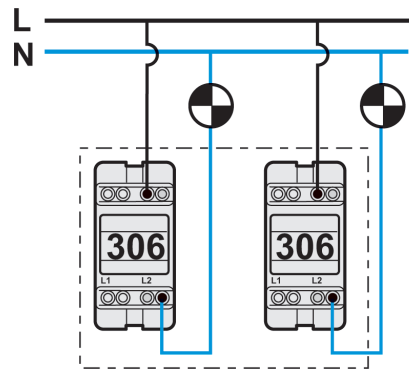

Double interrupteur unipolaire

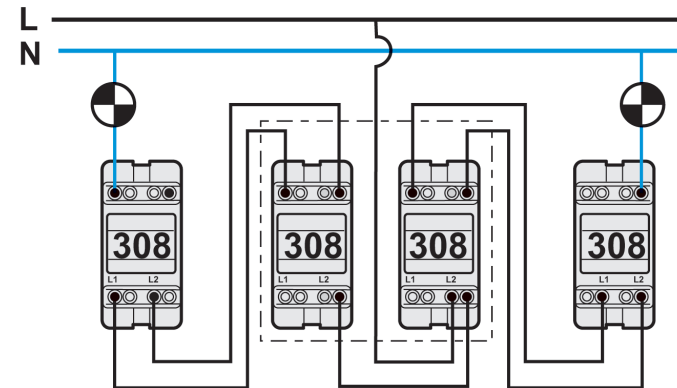

Double va-et-vient

Schémas de connexion

Porte-carte hôtel

| | |
|------------------|---|
| Tension nominale | 125/250V ~ |
| Courant nominal | 5(1)A et 2x5(1)A |
| Dimensions carte | 5,4x8,6cm, ↔ 0,76mm ISO7816 |
| Options | Mécanisme avec un ou deux microrupteurs |

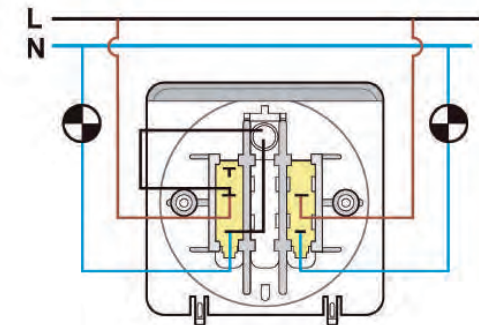
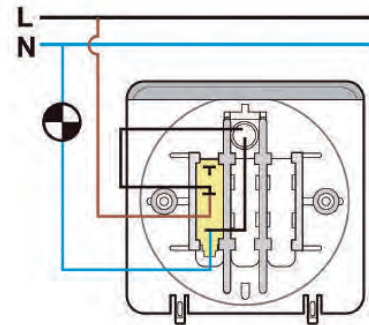

Détecteur de mouvement

| | |
|-----------------------------|--|
| Tension d'alimentation | 110-240VAC, 50/60Hz |
| Consommation | aprox. 0,5 W |
| Angle de détection | semi-circulaire 180° |
| Portée Ø H 1,10m/ T=18°C | Transversal 10m / frontal 3m Tangential 10m / radial 3m Transversale 10m / frontale 3m |
| Hauteur de montage max. | 2,2m |
| Contact | 2.300W, cosφ=1 1.150VA, cosφ=0,5 |
| Temporisation | 15 sec. to 16 min. or pulse |
| Valeur de luminosité | 10 - 2000 Lux |

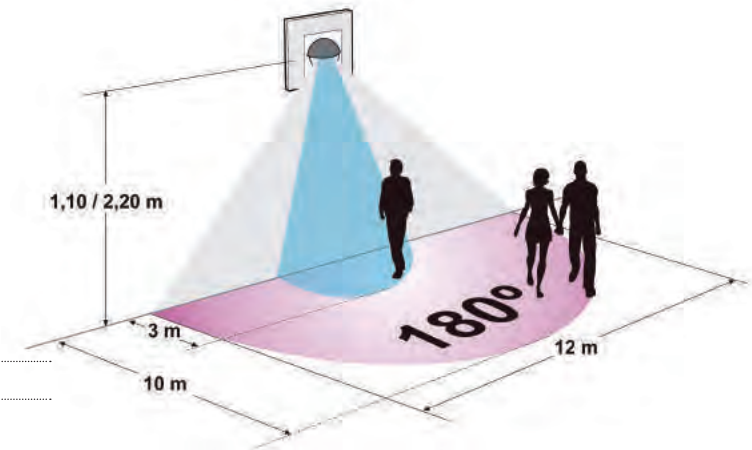
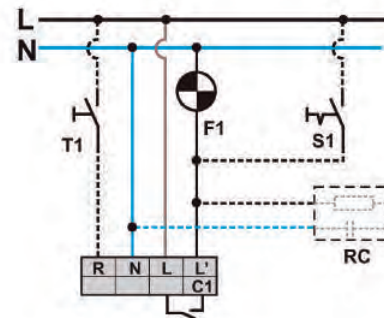

| | |
|-----------|--|
| Optionnel | |
| S1 | Interrupteur pour lumière permanente |
| T1 | Bouton avec contact NA ; pour commutation manuelle additionnelle |
| RC | Élément supprimeur RC si nécessaire |

Schémas de connexion

Thermostat

| | | | | | |
|-----------------------------|---------------------------|---------------------------------|--|---------|-------|
| Indicateur lumineux rouge | Demande de chaleur | Détecteur de température | Interne | | |
| Indicateur lumineux vert | Diminution de consigne | Diminution de consigne ambiante | Sélectionnable, 3K ou 5K | | |
| Interrupteur | Marche-arrêt | Limiteur de niveau | À l'intérieur de la roulette externe | | |
| Alimentation | 230V AC 50 Hz | Thermostat ambiant | Niveau de Température ambiante *...6 (5..30°C) | | |
| Sortie | Relais | Thermostat sol radiant | Niveau de température du sol*...5 (=10..50°C) | | |
| Intensité permanente | 100mA...16 A $\cos\phi=1$ | Caractéristiques de la sonde | | | |
| Différentiel de température | -0,5 °C | 10°C | 20°C | 30°C | 40°C |
| | | 66,8 kΩ | 41,3 kΩ | 26,3 kΩ | 17 kΩ |

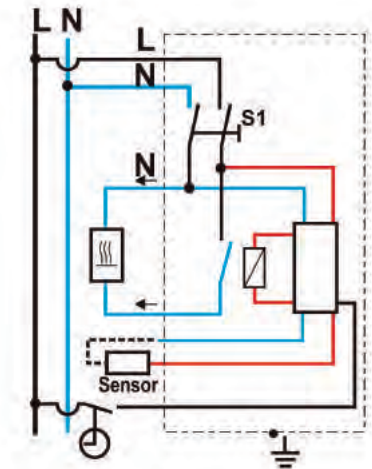

Chargeur USB 2 ports USB type A

| | |
|---|---|
| Tension d'entrée | AC 100...240V~, 50/60 Hz |
| Tension de sortie | DC 5V |
| Courant de sortie | 2.600 mA |
| Puissance absorbée sans chargement à UE=230V~ | ≤ 0,15 W |
| Connexion | Bornier à vis |
| Zone de la section transversale max. | 2 x 2,5 mm ² ó 2 x 1,5 mm ² |

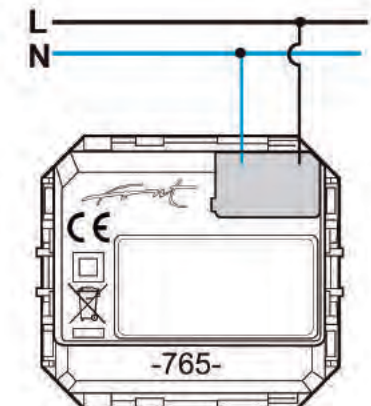

Schémas de connexion

Prises de télévision

Nombre maximum de prises : 8 (en fonction de la puissance du signal d'entrée).

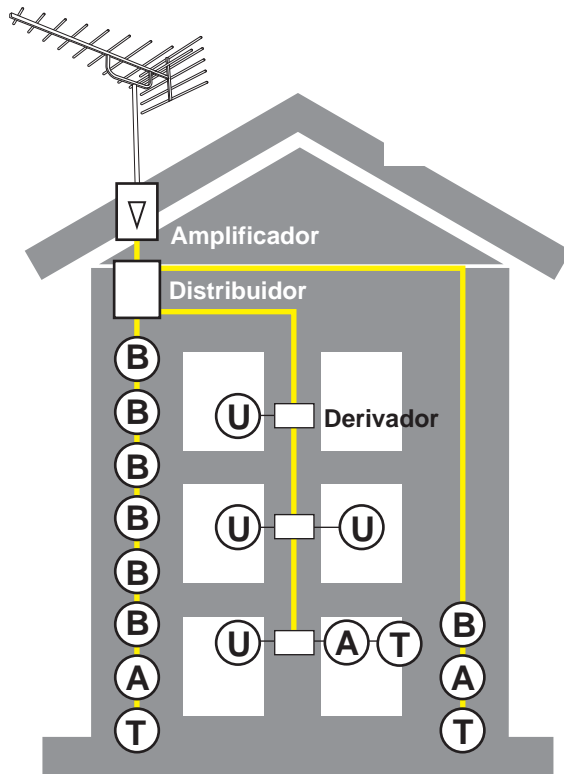
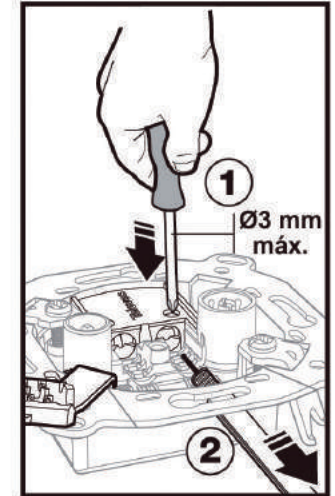
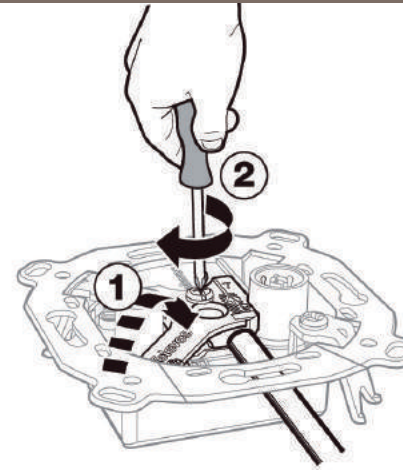
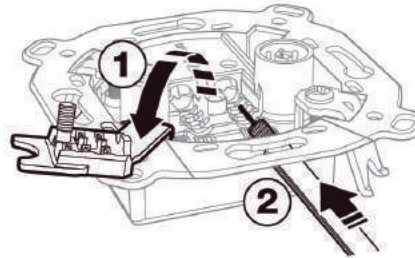
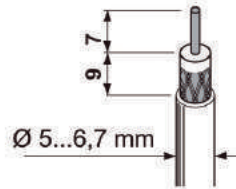

| | Pérdidas inserción typ (dB) Insertion losses typ (dB) Pertes insertion type (dB) | | OUT | Pérdidas derivación typ (dB) Derivation losses typ (dB) Pertes derivación typ (dB) | | Paso DC DC pass Passage DC 24V 350mA |
|--|--|------------------------|------|--|------------------------|---|
| | MATV 5-862 MHz | SAT-FI 950-2150 MHz | | MATV 5-862 MHz | SAT-FI 950-2150 MHz | |
| Toma única Single socket Prise unique | --- | --- | R/TV | 0,6 | --- | SAT → ↑↓ |
| Toma intermedia Intermediate socket Prise intermédiaire B | 1,2 | 2 | R/TV | 13 | 13,5 | ↑↓ ↔ ↑↓ |
| | | | SAT | 13 | 14 | SAT → ↑↓ |
| Toma intermedia Intermediate socket Prise intermédiaire A | 3,5 | 5 | R/TV | 8,5 | 9 | ↑↓ ↔ ↑↓ |
| | | | SAT | 7,5 | 10 | SAT → ↑↓ |
| Toma final Final socket Prise finale | --- | --- | R/TV | 4 | 5 | SAT → ↑↓ |
| | | | SAT | 4 | 5 | SAT → ↑↓ |

Fontini

Pol. Ind. Can Bernades-Subirà, C/ Anòia, 15
08130 Santa Perpètua de Mogoda (Barcelona) Spain
Tel. +34 93 574 33 30
www.fontini.fr